

## 1-Line, Bi-directional, Transient Voltage Suppressor

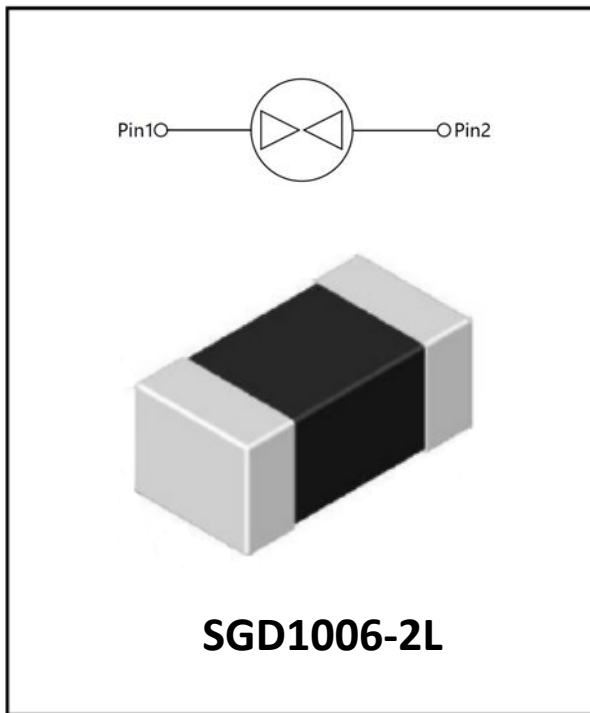

### Features

- Ultra small package
- Stand-off voltage: 24V Max
- Transient protection for each line according to  
IEC61000-4-2(ESD):  $\pm 25\text{kV}$  (air)  
IEC61000-4-2(ESD):  $\pm 15\text{kV}$  (contact)
- Low leakage current
- Low clamping voltage
- RoHS Compliant

### Applications

- Smart Phone/Mobile Interment Device
- Loptop/Desktop Computer
- Antennas
- High Speed Ethernet
- Lightning and Thunder Bolt interface
- USB 2.0 and USB 3.0

### Mechanical Characteristics

- Package: SGD1006-2L
- Moisture Sensitivity: Level 1 per J-STD-020
- Case Material: Glass Fiber Epoxy Resin
- Marking Information: None

### ■ Absolute Maximum Ratings ( $T_a=25^\circ\text{C}$ unless otherwise specified)

PARAMETER	SYMBOL	Value	Units
Response time	Trise	<0.5	ns
ESD according to IEC61000-4-2 air discharge	V <sub>ESD</sub>	$\pm 25$	kV
ESD according to IEC61000-4-2 contact discharge		$\pm 15$	
Operation ambient temperature	T <sub>OPT</sub>	-55~+125	°C
Storage temperature range	T <sub>STG</sub>	-55~+150	°C

### ■ Electrical Characteristics ( $T_a=25^\circ\text{C}$ Unless otherwise specified)

Part No.	Working Voltage	Typical Trigger Voltage	ESD Typical ESD Clamping Voltage at 60ns	Leakage Current (at Initial State)	Leakage Current (after ESD Test)	Cap. Value at 1MHz (typ)	Cap. Value at 1MHz (max)
Symbol	VDC (max)	V <sub>trigger</sub> (typ)	VC (typ)	ILDC	ILDCA	C <sub>j</sub> (typ)	C <sub>j</sub> (max)
Unit	V	V	V	$\mu\text{A}$	$\mu\text{A}$	pF	pF
ESDM6V0M1	6	300	30	<0.1	<0.1	0.05	0.08
ESDM12VM1	12	300	30	<0.1	<0.1	0.05	0.08
ESDM24VM1	24	300	30	<0.1	<0.1	0.05	0.08



# ESDM6V0M1-ESDM24VM1

## ■ Ordering Information (Example)

PREFERED P/N	UNIT WEIGHT(mg)	MINIMUM PACKAGE(pcs)	INNER BOX QUANTITY(pcs)	OUTER CARTON QUANTITY(pcs)	DELIVERY MODE
ESDM6V0M1~ ESDM24VM1	Approximate 0.59	10000	100000	400000	Tae& reel

## ■ ESD Testing Circuit and Testing Results

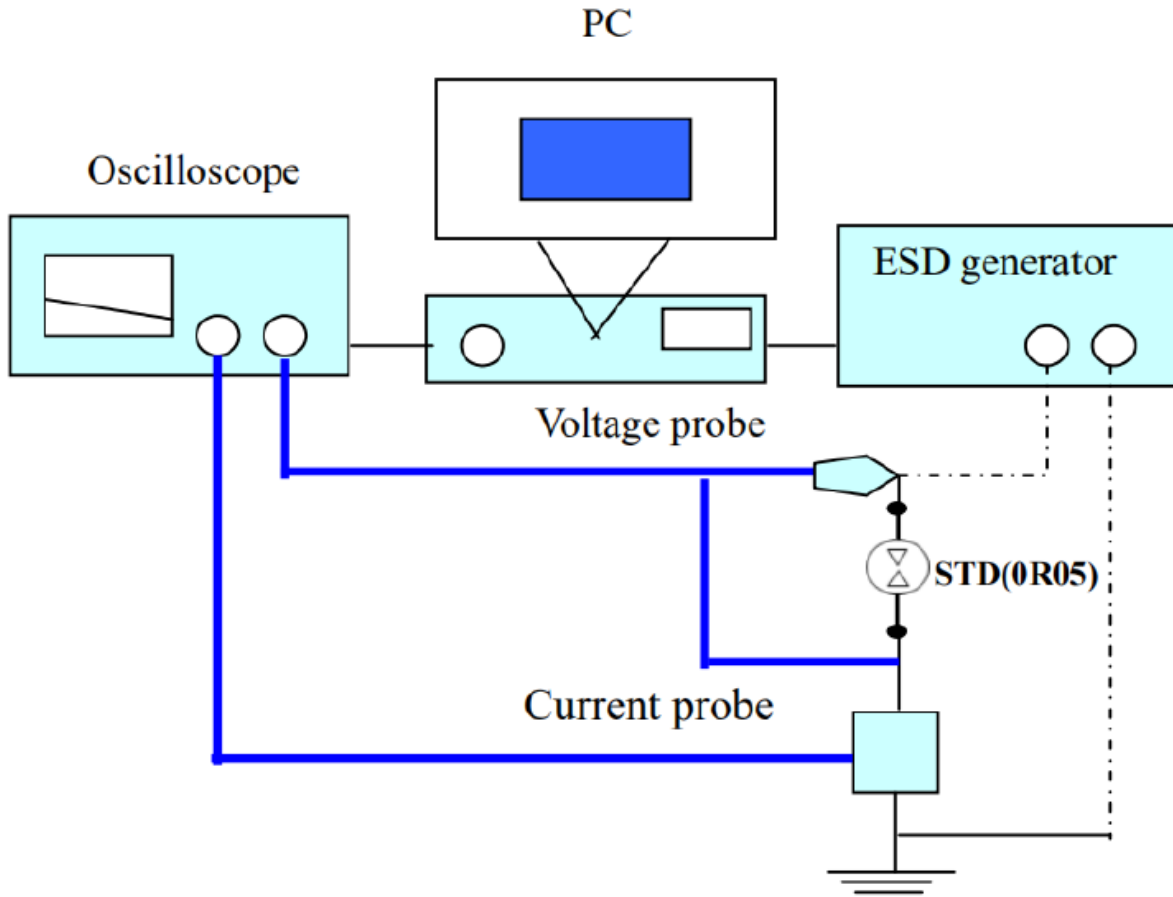
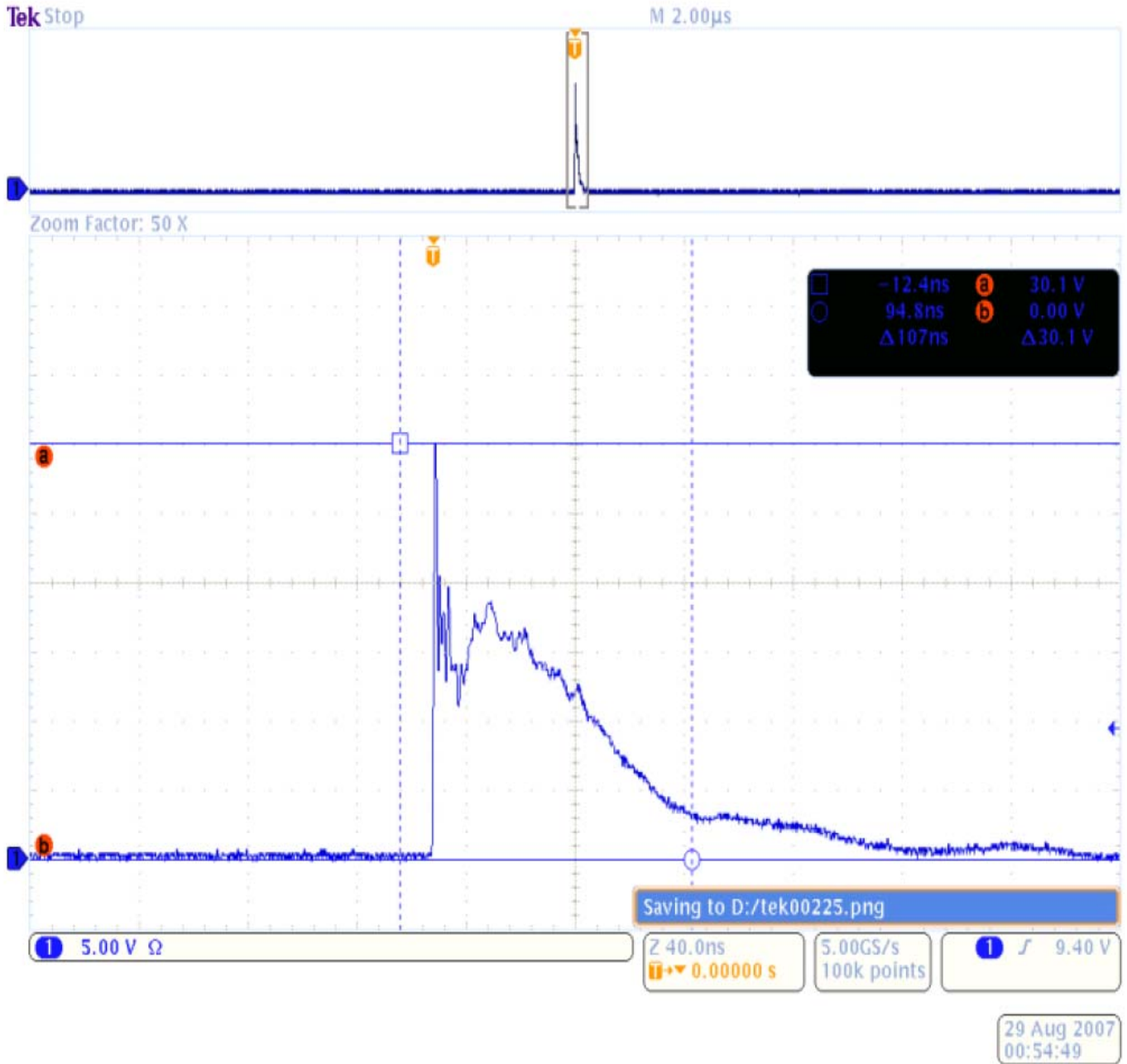

Fig 2 (A) ESD testing circuit



Test with high voltage probe of attenuation factor ×250  
Fig 2 (B) without ESD protection sample

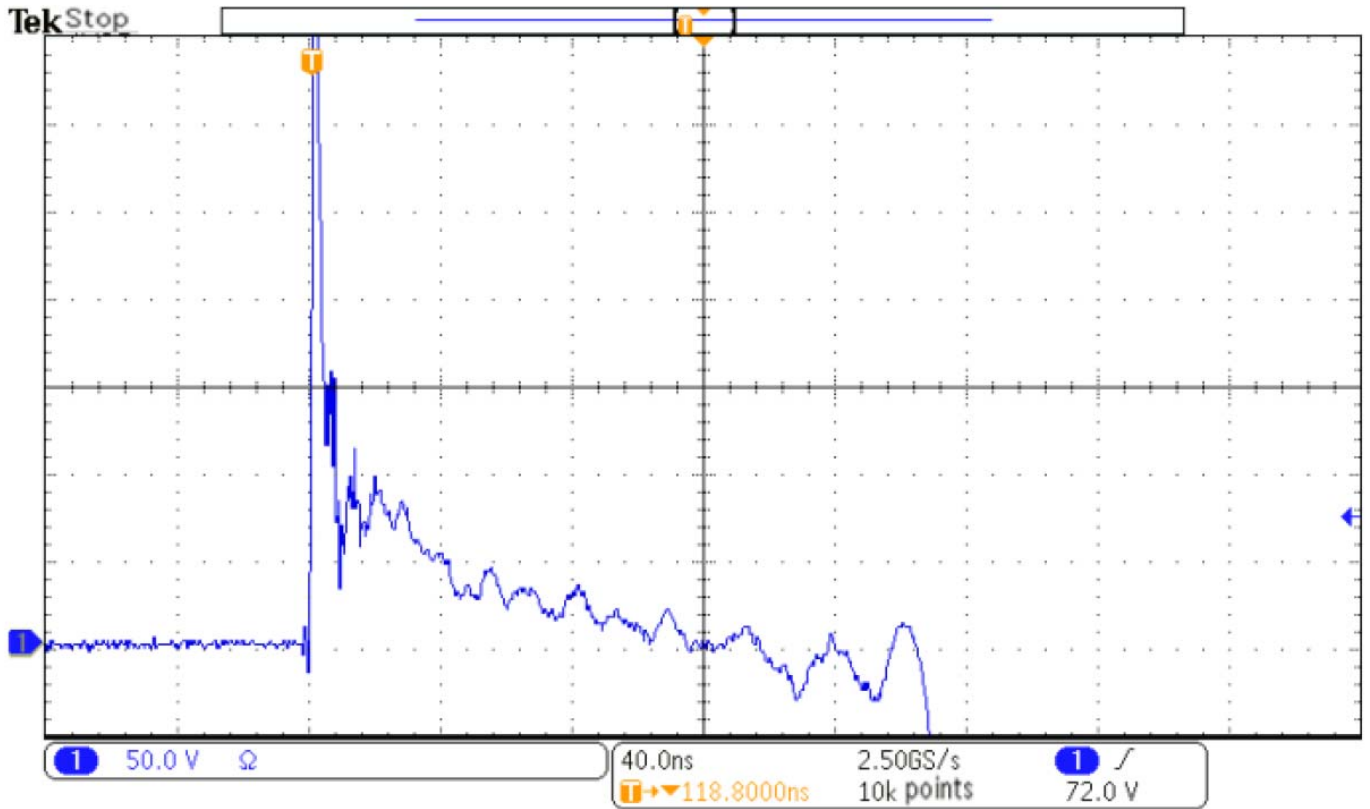

Fig 2 (C) with ESD protection sample

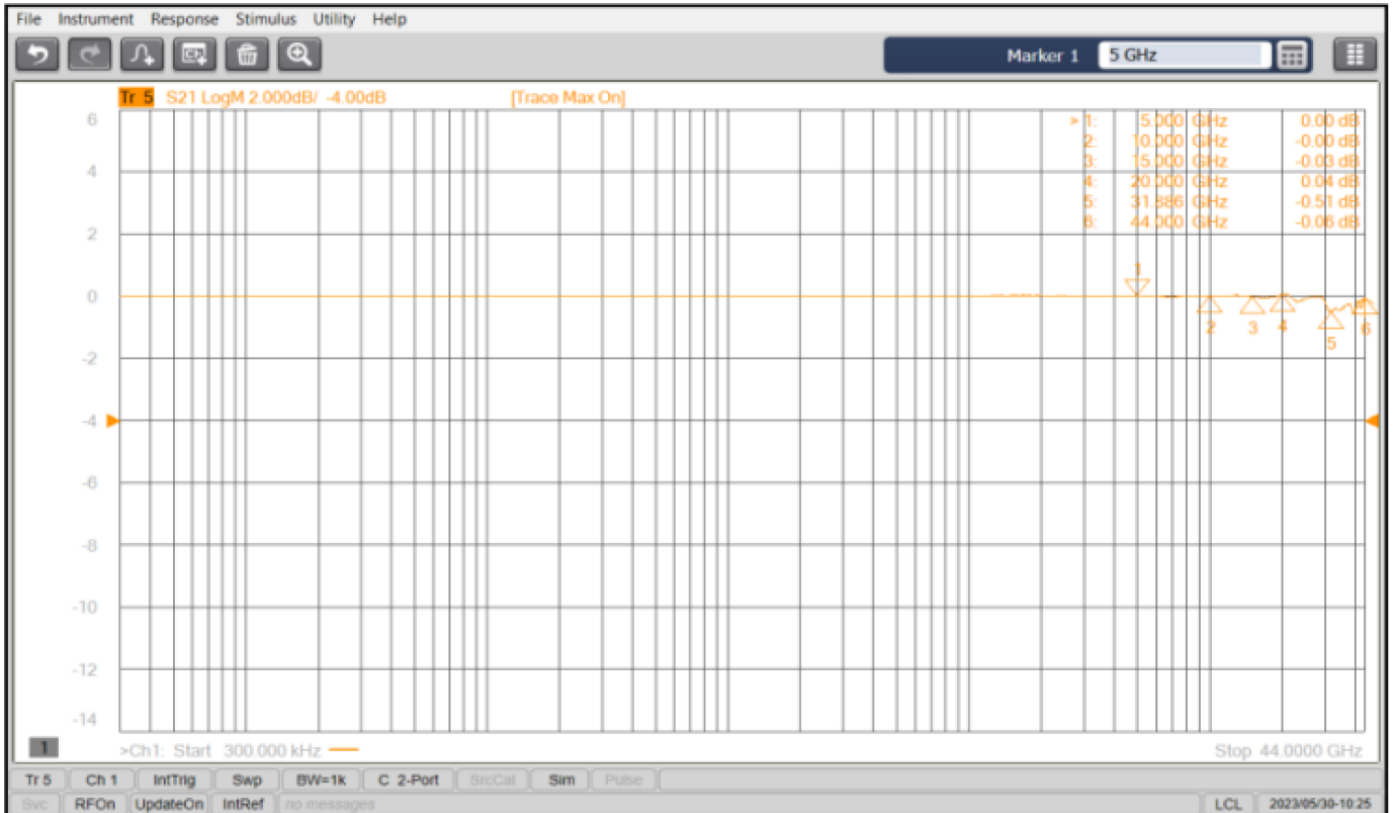

Fig 3(A) Insertion loss



# ESDM6V0M1-ESDM24VM1

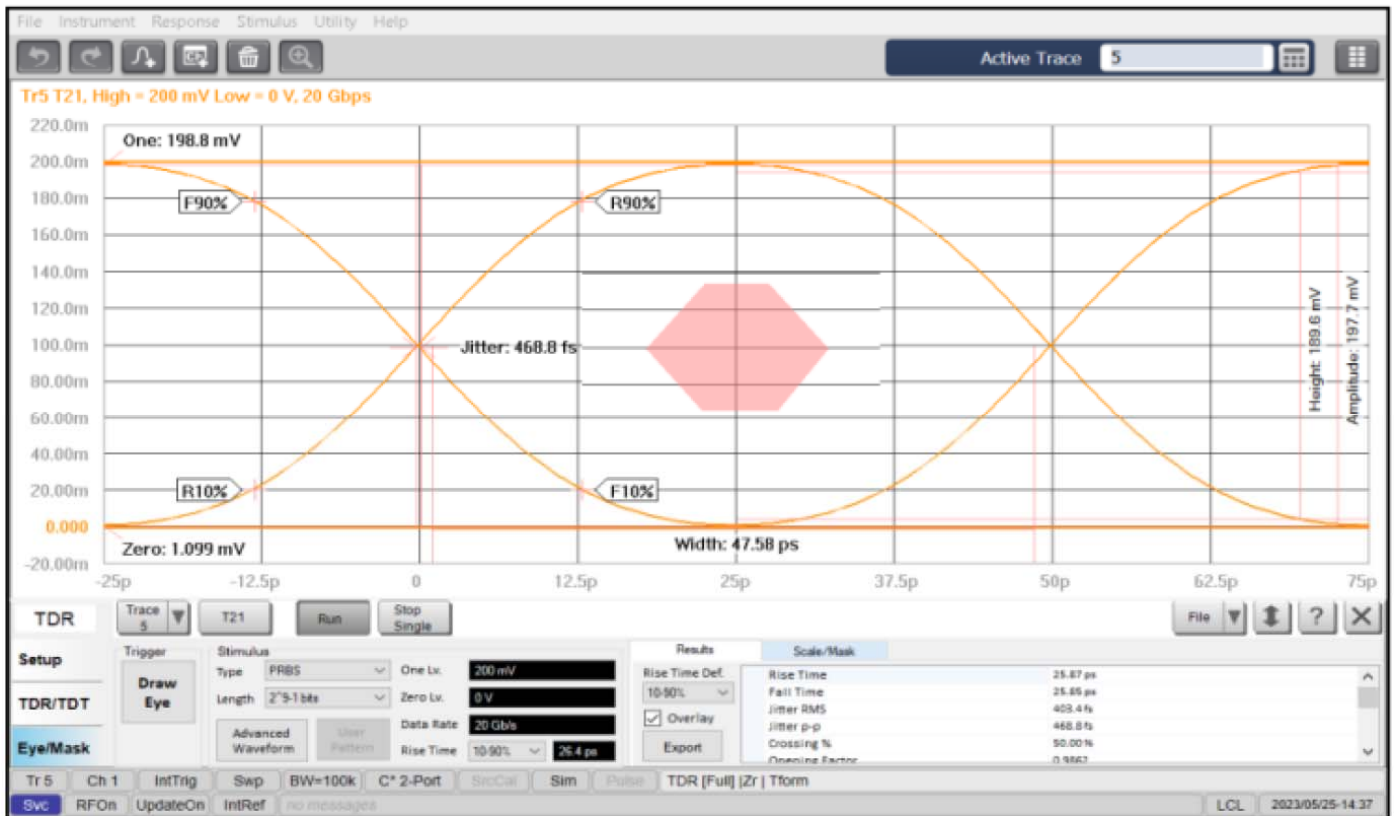

Fig 3(B) Eye pattern



# ESDM6V0M1-ESDM24VM1

## ■ Outline Dimensions

<b>Model</b>	SGD1006
Length (L)	1.00±0.10
Width (W)	0.60±0.10
Thickness (T)	0.50±0.10
Termination (a)	0.25±0.10

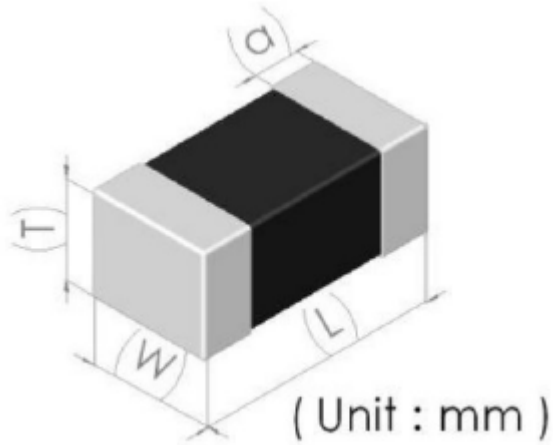

## ■ Recommend land pattern (Unit:mm)

(Unit:mm)

	A	B	C
0402	0.3~0.5	0.5~0.7	0.6~0.7

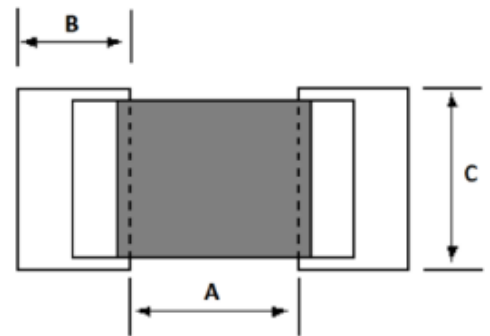



# ESDM6V0M1-ESDM24VM1

---

## Disclaimer

The information presented in this document is for reference only. Yangzhou Yangjie Electronic Technology Co., Ltd. reserves the right to make changes without notice for the specification of the products displayed herein to improve reliability, function or design or otherwise.

The product listed herein is designed to be used with ordinary electronic equipment or devices, and not designed to be used with equipment or devices which require high level of reliability and the malfunction of which would directly endanger human life (such as medical instruments, transportation equipment, aerospace machinery, nuclear-reactor controllers, fuel controllers and other safety devices), Yangjie or anyone on its behalf, assumes no responsibility or liability for any damages resulting from such improper use of sale.

This publication supersedes & replaces all information previously supplied. For additional information, please visit our website [http:// www.21yangjie.com](http://www.21yangjie.com) , or consult your nearest Yangjie's sales office for further assistance.