



Thyristor Module

V_{RRM} / V_{DRM} 800 to 1800V
I_{TAV} 25A

Applications

- Power Converters
- Lighting Control
- DC Motor Control and Drives
- Heat and temperature control

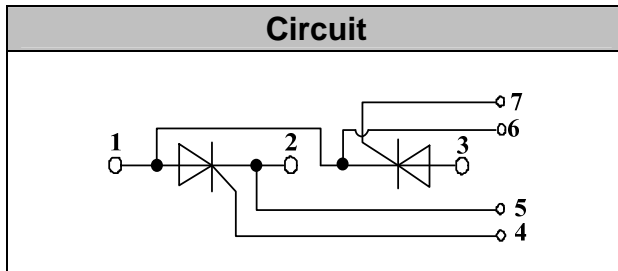

Features

- International standard package
- High Surge Capability
- Glass passivated chip
- Simple Mounting
- Heat transfer through aluminum oxide DBC ceramic isolated metal baseplate
- UL recognized applied for file no. E360040

Module Type

TYPE	V _{RRM}	V _{RSM}
MT25C08T1	800V	900V
MT25C12T1	1200V	1300V
MT25C16T1	1600V	1700V
MT25C18T1	1800V	1900V

Maximum Ratings

Symbol	Conditions	Values	Units
I _{TAV}	Sine 180°;T _c =85°C	25	A
I _{TSM}	T _{VJ} =45°C t=10ms, sine T _{VJ} =125°C t=10ms, sine	550 480	A
i ² t	T _{VJ} =45°C t=10ms, sine T _{VJ} =125°C t=10ms, sine	1500 1150	A ² s
Visol	a.c.50HZ;r.m.s.;1min	3000	V
T _{vj}		-40 to 125	°C
T _{stg}		-40 to 125	°C
M _t	To terminals(M5)	3±15%	Nm
M _s	To heatsink(M6)	5±15%	Nm
di/dt	T _{VJ} = T _{VJM} , 2/3V _{DRM} ,I _G =500mA Tr<0.5us,tp>6us	150	A/us
dv/dt	T _J = T _{VJM} ,2/3V _{DRM} linear voltage rise	1000	V/us
a	Maximum allowable acceleration	50	m/s ²
Weight	Module(Approximately)	100	g

Thermal Characteristics

Symbol	Conditions	Values	Units
R _{th(j-c)}	Cont.;per thyristor / per module	0.9/0.45	°C/W
R _{th(c-s)}	per thyristor / per module	0.2/0.1	°C/W



Electrical Characteristics

Symbol	Conditions	Values			Units
		Min.	Typ.	Max.	
V_{TM}	$T=25^{\circ}\text{C}$ $I_{TM}=75\text{A}$			1.8	V
I_{RRM}/I_{DRM}	$T_{VJ}=T_{VJM}$, $V_R=V_{RRM}$, $V_D=V_{DRM}$			10	mA
V_{TO}	For power-loss calculations only ($T_{VJ}=125^{\circ}\text{C}$)			0.9	V
r_T	$T_{VJ}=T_{VJM}$			12	m Ω
V_{GT}	$T_{VJ}=25^{\circ}\text{C}$, $V_D=6\text{V}$			2.5	V
I_{GT}	$T_{VJ}=25^{\circ}\text{C}$, $V_D=6\text{V}$			150	mA
V_{GD}	$T_{VJ}=125^{\circ}\text{C}$, $V_D=2/3V_{DRM}$			0.25	V
I_{GD}	$T_{VJ}=125^{\circ}\text{C}$, $V_D=2/3V_{DRM}$			5	mA
I_L	$T_{VJ}=25^{\circ}\text{C}$, $R_G=33\ \Omega$		250	400	mA
I_H	$T_{VJ}=25^{\circ}\text{C}$, $V_D=6\text{V}$		100	200	mA
tgd	$T_{VJ}=25^{\circ}\text{C}$, $I_G=1\text{A}$, $di_G/dt=1\text{A/us}$		1		us
tq	$T_{VJ}=T_{VJM}$		80		us



Performance Curves

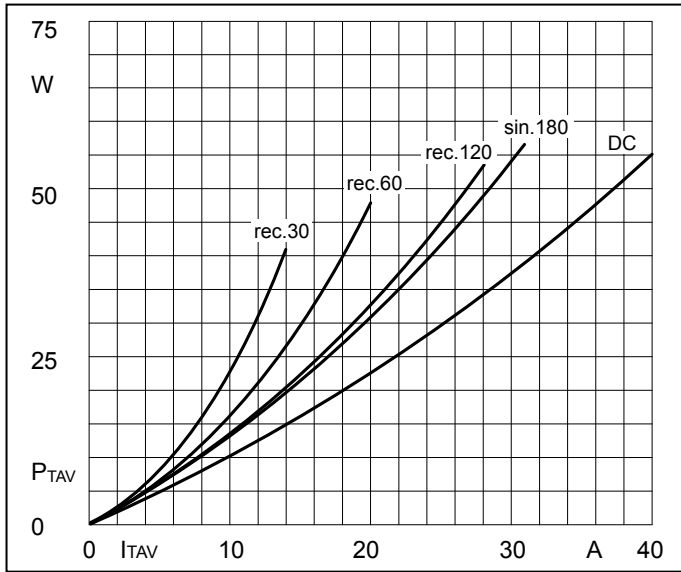

Fig1. Power dissipation

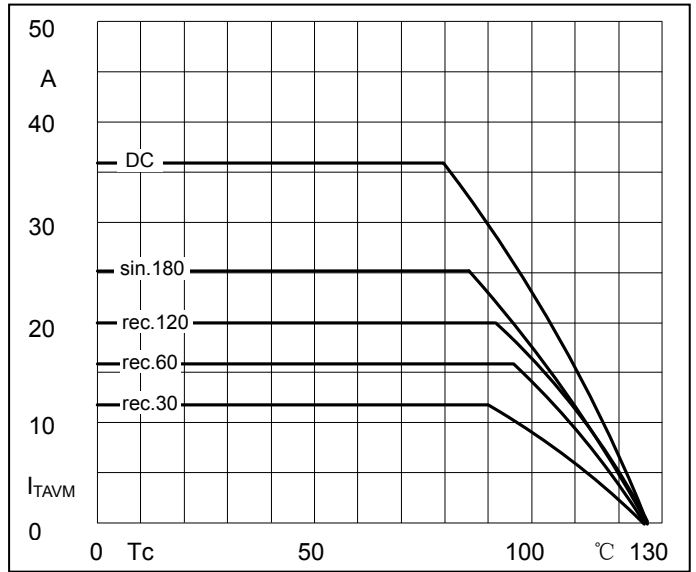

Fig2. Forward Current Derating Curve

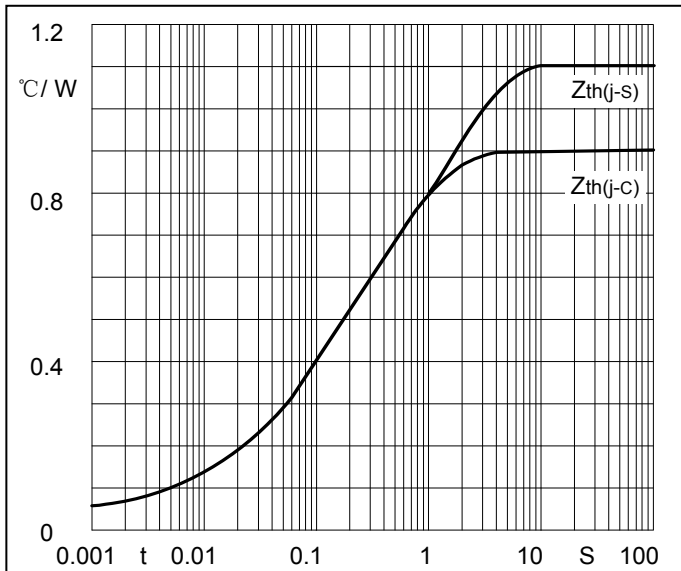

Fig3. Transient thermal impedance

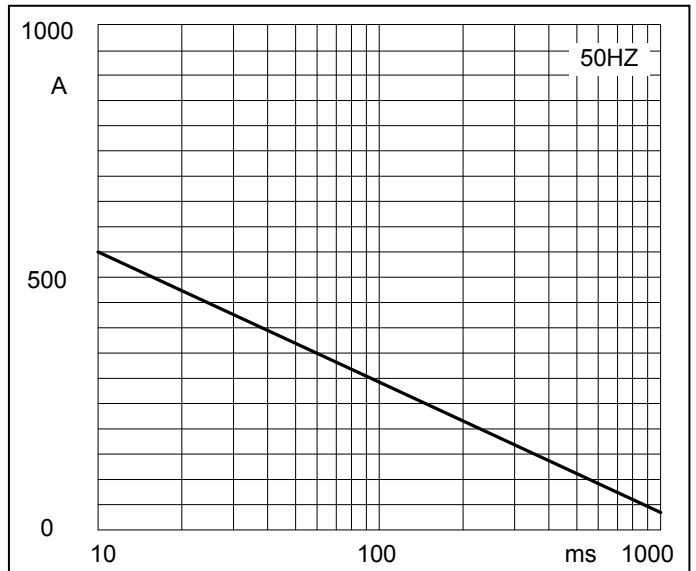

Fig4. Max Non-Repetitive Forward Surge Current

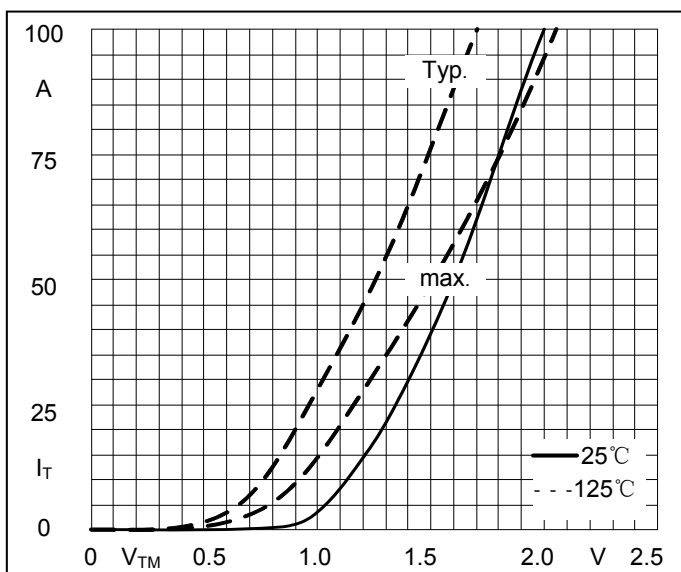

Fig5. Forward Characteristics

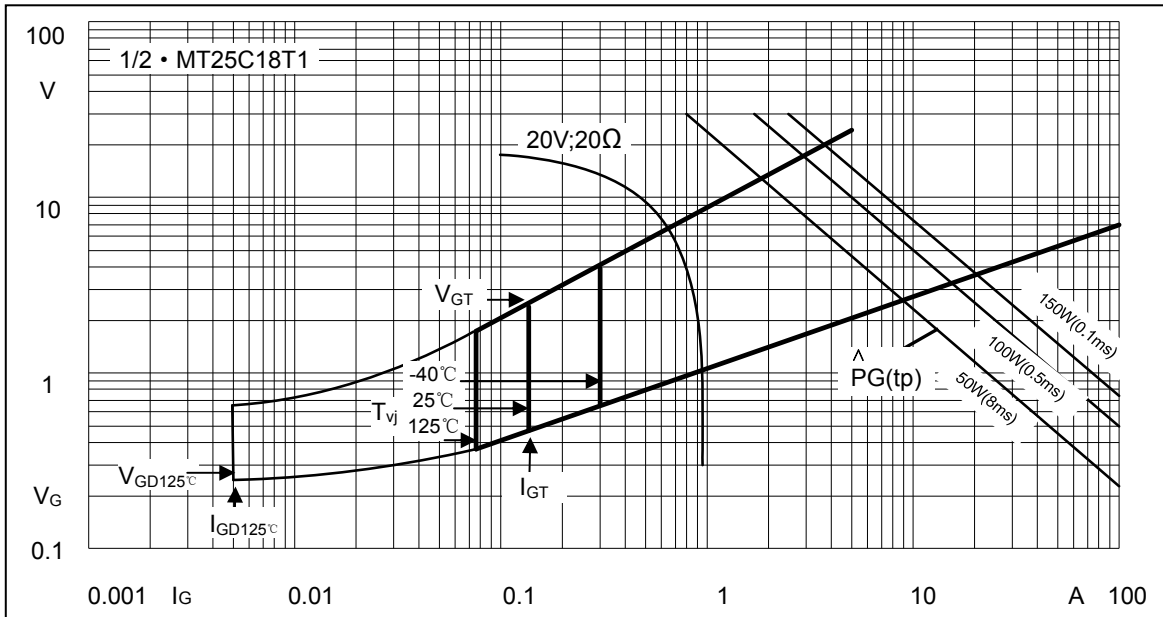
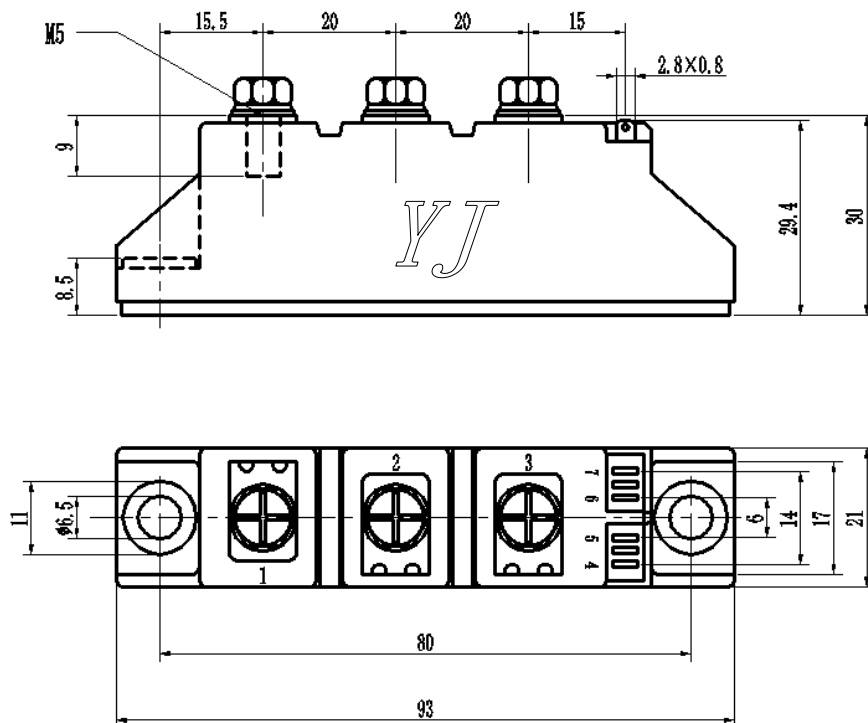

Fig6. Gate trigger Characteristics

Package Outline Information

CASE: T1



Dimensions in mm