

## N-Channel Enhancement Mode Field Effect Transistor

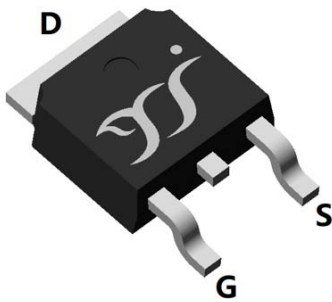

Top View

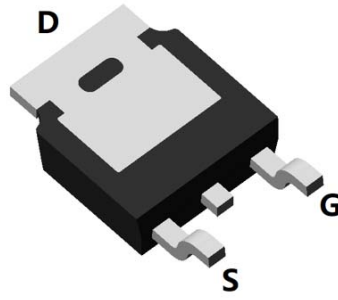

Bottom View

**TO-252**

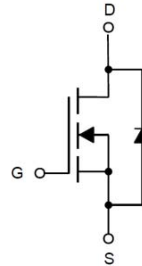

### Product Summary

- $V_{DS}$  60V
- $I_D$  80A
- $R_{DS(on)}$  ( at  $V_{GS}=10V$ )  $<7.5m\Omega$
- $R_{DS(on)}$  ( at  $V_{GS}=4.5V$ )  $<10m\Omega$
- 100% EAS Tested
- 100%  $\nabla V_{DS}$  Tested

### General Description

- Low  $R_{DS(on)}$  & FOM
- Extremely low switching loss
- Excellent stability and uniformity
- Fast switching and soft recovery
- Part no. with suffix "Q" means AEC-Q101 qualified

### Applications

- Power switching application
- Hard switched and high frequency circuits
- Uninterruptible power supply
- DC-DC convertor
- 12V and 24V Automotive systems

### ■ Absolute Maximum Ratings ( $T_A=25^\circ C$ unless otherwise noted)

Parameter		Symbol	Limit	Unit
Drain-source Voltage		$V_{DS}$	60	V
Gate-source Voltage		$V_{GS}$	$\pm 20$	V
Drain Current	$T_C=25^\circ C$	$I_D$	80	A
	$T_C=100^\circ C$		50	
Pulsed Drain Current <sup>A</sup>		$I_{DM}$	240	A
Avalanche energy <sup>B</sup>		EAS	144	mJ
Total Power Dissipation <sup>C</sup>	$T_C=25^\circ C$	$P_D$	78	W
	$T_C=100^\circ C$		31	
Junction and Storage Temperature Range		$T_J, T_{STG}$	-55~+150	$^\circ C$



# YJD80G06CQ

## ■ Thermal resistance

Parameter		Symbol	Typ	Max	Units
Thermal Resistance Junction-to-Ambient <sup>D</sup>	Steady-State	$R_{\theta JA}$	40	50	°C/W
Thermal Resistance Junction-to-Case	Steady-State	$R_{\theta JC}$	1.3	1.6	

## ■ Ordering Information (Example)

PREFERRED P/N	PACKING CODE	Marking	MINIMUM PACKAGE(pcs)	INNER BOX QUANTITY(pcs)	OUTER CARTON QUANTITY(pcs)	DELIVERY MODE
YJD80G06CQ	F1	YJD80G06C	2500	/	25000	13"Reel

- A. Repetitive rating; pulse width limited by max. junction temperature.
- B.  $T_J=25^{\circ}\text{C}$ ,  $V_{DD}=40\text{V}$ ,  $V_G=10\text{V}$ ,  $R_G=25\Omega$ ,  $L=0.5\text{mH}$ ,  $I_{AS}=24\text{A}$ .
- C.  $P_q$  is based on max. junction temperature, using junction-case thermal resistance.
- D. The value of  $R_{\theta JA}$  is measured with the device mounted on the minimum recommend pad size, in the still air environment with  $T_A=25^{\circ}\text{C}$ . The maximum allowed junction temperature of  $150^{\circ}\text{C}$ . The value in any given application depends on the user's specific board design.



# YJD80G06CQ

## ■ Electrical Characteristics (T<sub>J</sub>=25°C unless otherwise noted)

Parameter	Symbol	Conditions	Min	Typ	Max	Units
<b>Static Parameter</b>						
Drain-Source Breakdown Voltage	BV <sub>DSS</sub>	V <sub>GS</sub> =0V, I <sub>D</sub> =250μA	60			V
Zero Gate Voltage Drain Current	I <sub>DSS</sub>	V <sub>DS</sub> =60V, V <sub>GS</sub> =0V			1	μA
Gate-Body Leakage Current	I <sub>GSS</sub>	V <sub>GS</sub> = ±20V, V <sub>DS</sub> =0V			±100	nA
Gate Threshold Voltage	V <sub>GS(th)</sub>	V <sub>DS</sub> = V <sub>GS</sub> , I <sub>D</sub> =250μA	1.2	1.7	2.5	V
Static Drain-Source On-Resistance	R <sub>DS(on)</sub>	V <sub>GS</sub> =10V, I <sub>D</sub> =20A		5.5	7.5	mΩ
		V <sub>GS</sub> =4.5V, I <sub>D</sub> =10A		6.5	10	
Diode Forward Voltage	V <sub>SD</sub>	I <sub>S</sub> =20A, V <sub>GS</sub> =0V		0.85	1.3	V
Maximum Body-Diode Continuous Current	I <sub>S</sub>				80	A
Gate resistance	R <sub>G</sub>	f=1MHz		1.5		Ω
<b>Dynamic Parameters</b>						
Input Capacitance	C <sub>iss</sub>	V <sub>DS</sub> =25V, V <sub>GS</sub> =0V, f=1MHz	-	2100	-	pF
Output Capacitance	C <sub>oss</sub>		-	670	-	
Reverse Transfer Capacitance	C <sub>rss</sub>		-	30	-	
<b>Switching Parameters</b>						
Total Gate Charge	Q <sub>g</sub>	V <sub>GS</sub> =10V, V <sub>DS</sub> =30V, I <sub>D</sub> =20A	-	31	-	nC
Gate-Source Charge	Q <sub>gs</sub>		-	6	-	
Gate-Drain Charge	Q <sub>gd</sub>		-	5	-	
Reverse Recovery Charge	Q <sub>rr</sub>	I <sub>F</sub> =20A, di/dt=500A/us	-	18	-	nC
Reverse Recovery Time	t <sub>rr</sub>		-	30	-	ns
Turn-on Delay Time	t <sub>D(on)</sub>	V <sub>GS</sub> =10V, V <sub>DD</sub> =30V, I <sub>D</sub> =20A R <sub>GEN</sub> =3Ω	-	10	-	ns
Turn-on Rise Time	t <sub>r</sub>		-	34	-	
Turn-off Delay Time	t <sub>D(off)</sub>		-	26.2	-	
Turn-off fall Time	t <sub>f</sub>		-	45	-	



# YJD80G06CQ

## Typical Electrical and Thermal Characteristics Diagrams

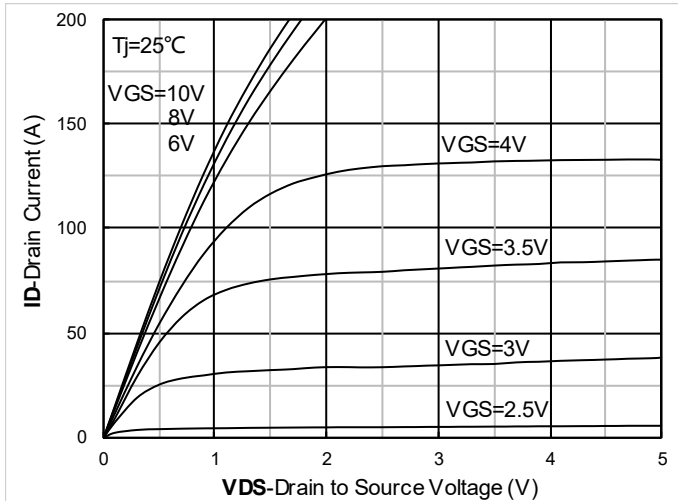

Figure 1. Output Characteristics

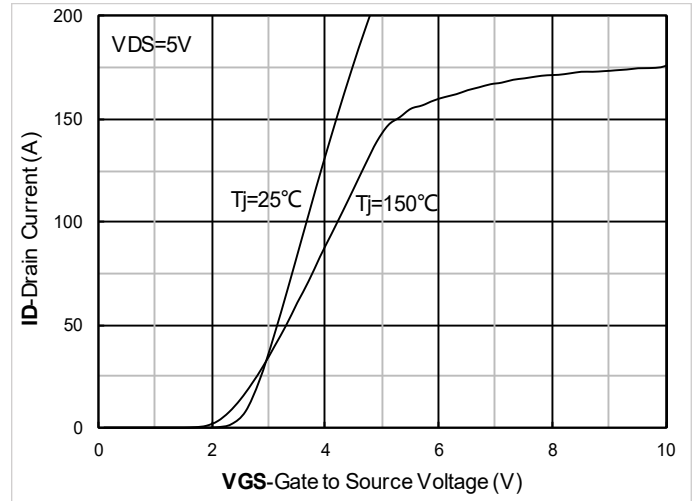

Figure 2. Transfer Characteristics

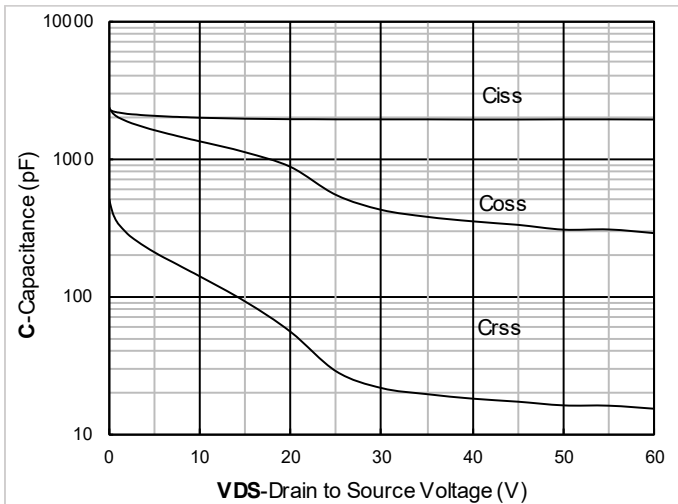

Figure 3. Capacitance Characteristics

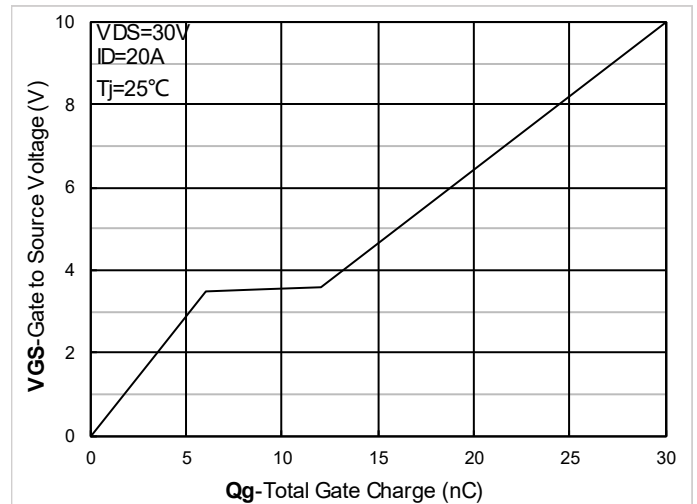

Figure 4. Gate Charge

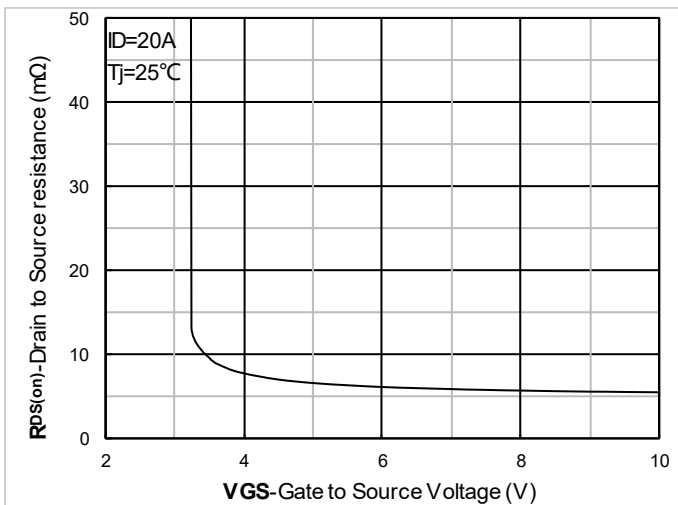

Figure 5. On-Resistance vs Gate to Source Voltage

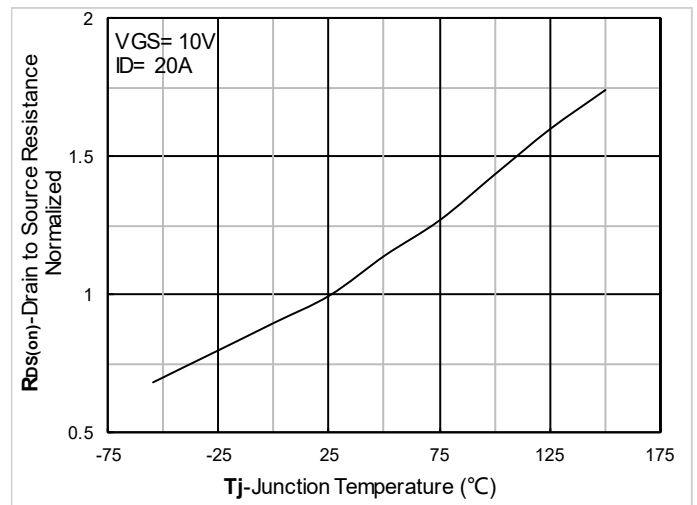

Figure 6. Normalized On-Resistance



# YJD80G06CQ

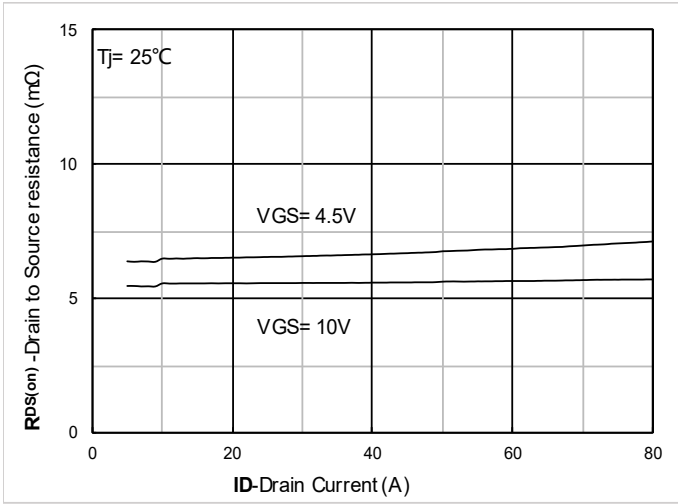

Figure 7.  $R_{DS(on)}$  VS Drain Current

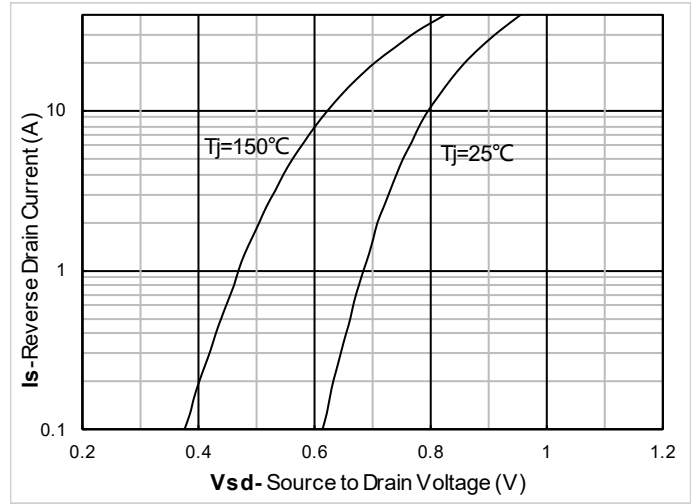

Figure 8. Forward characteristics of reverse diode

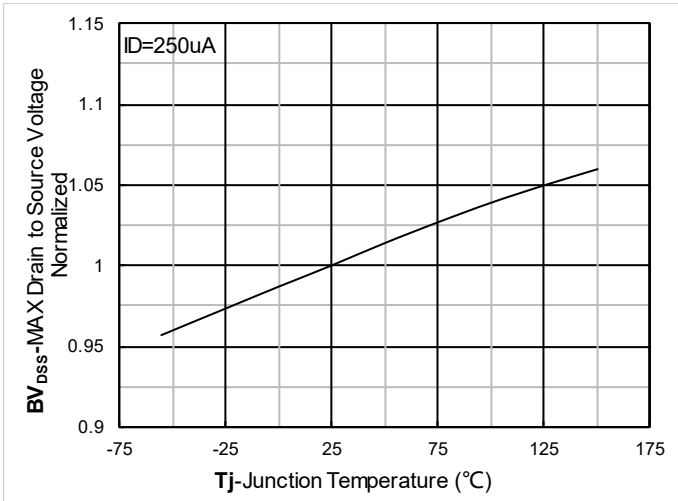

Figure 9. Normalized breakdown voltage

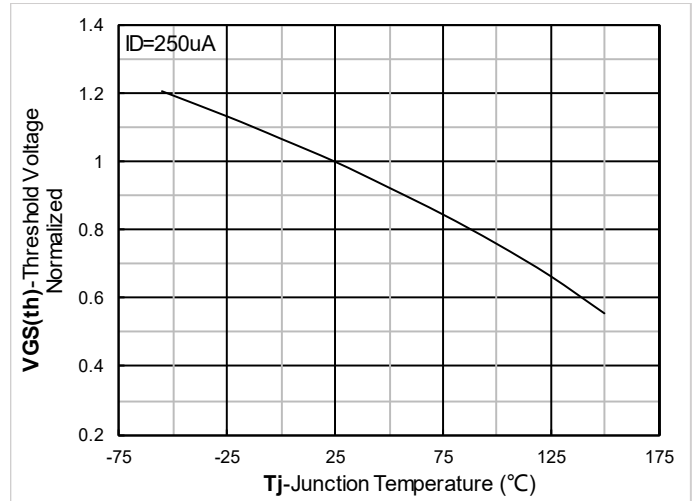

Figure 10. Normalized Threshold voltage

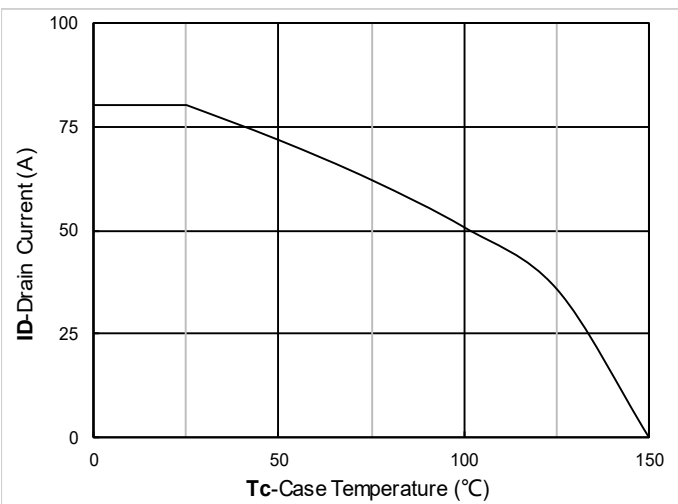

Figure 11. Current dissipation

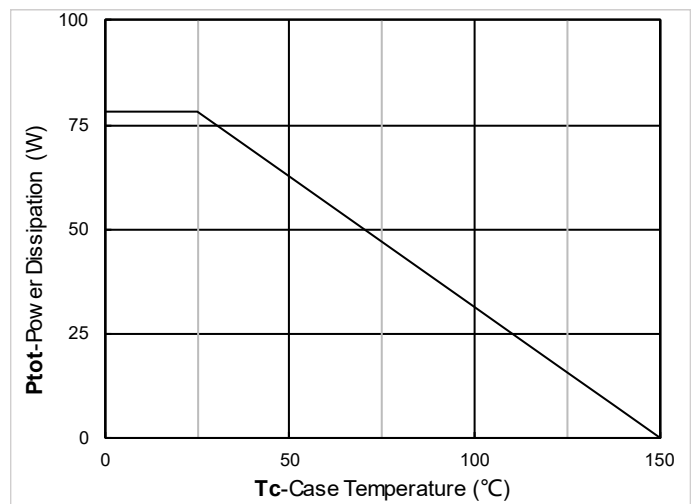

Figure 12. Power dissipation



# YJD80G06CQ

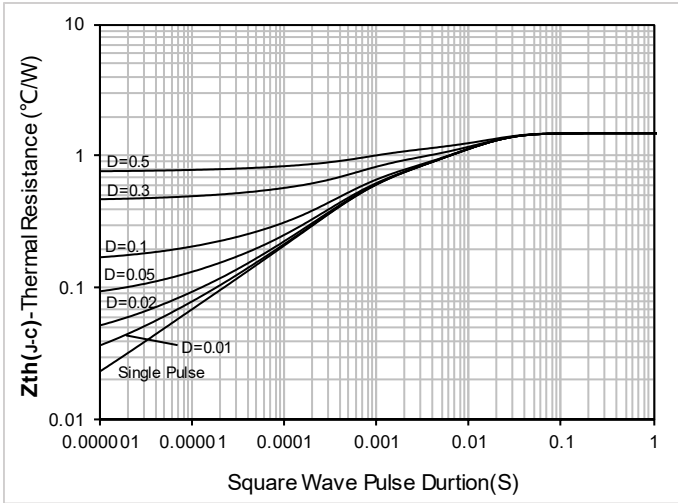

Figure 13. Maximum Transient Thermal Impedance

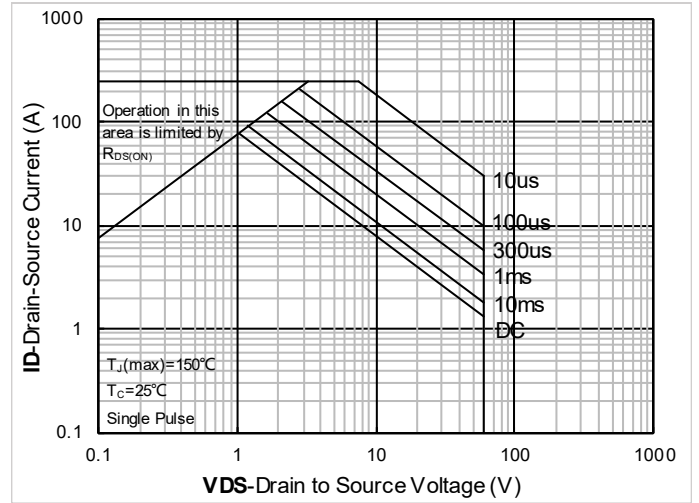

Figure 14. Safe Operation Area

## ■ Test Circuits & Waveforms

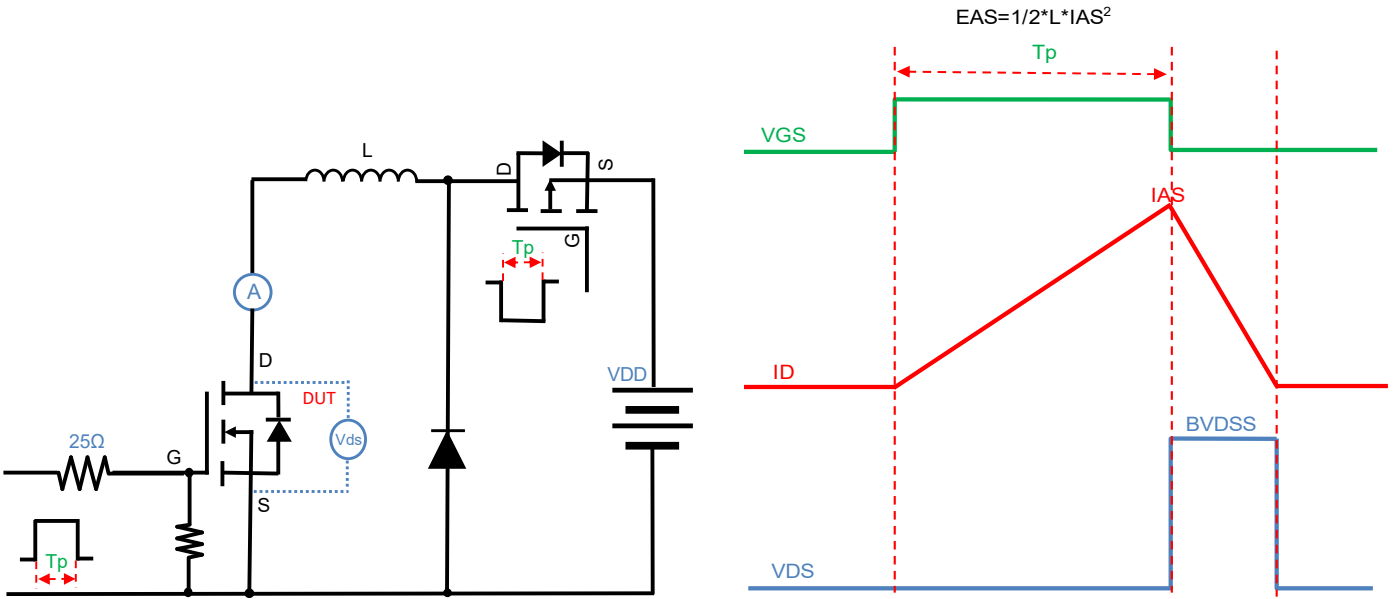

Figure A. Unclamped Inductive Switching (UIS) Test Circuit & Waveform

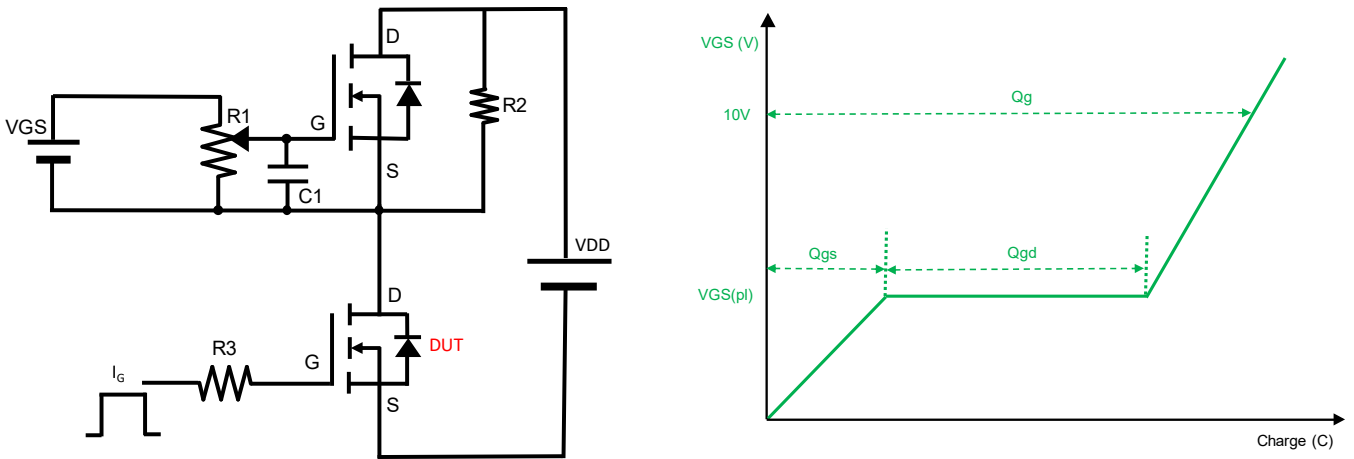

Figure B. Gate Charge Test Circuit & Waveform

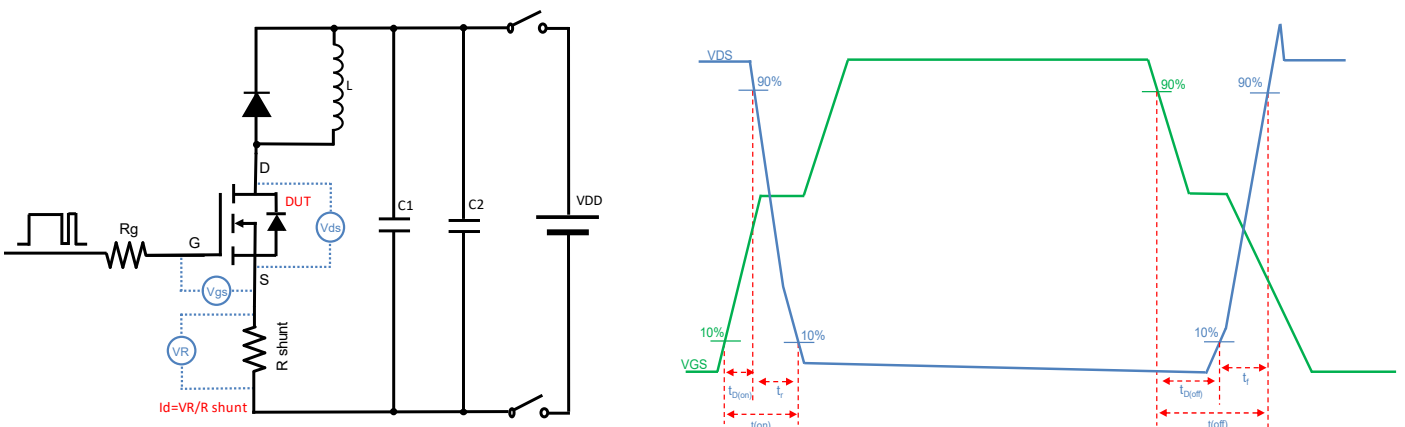

Figure C. Resistive Switching Test Circuit & Waveform

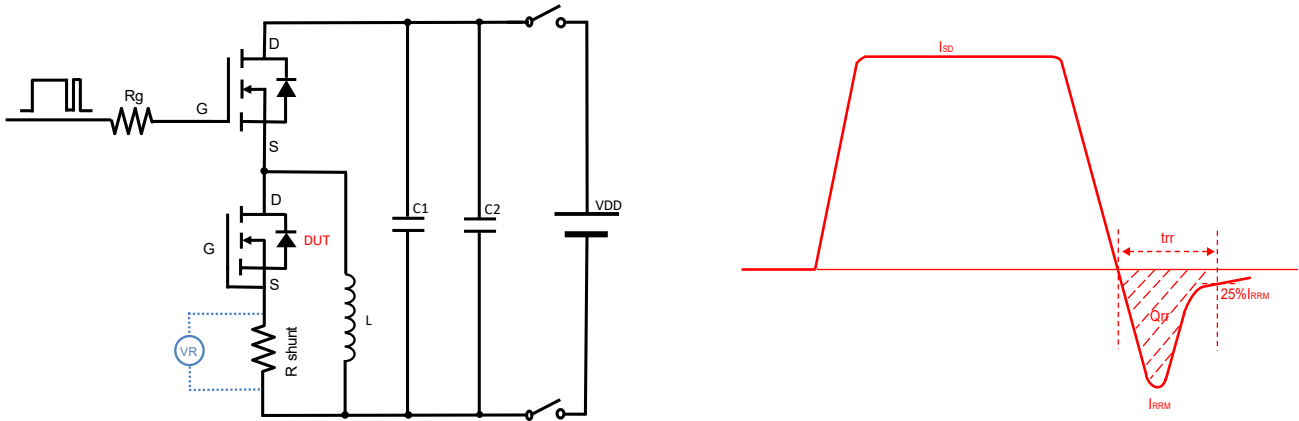

Figure D. Diode Recovery Test Circuit & Waveform





# YJD80G06CQ

## ■ TO-252 Package information

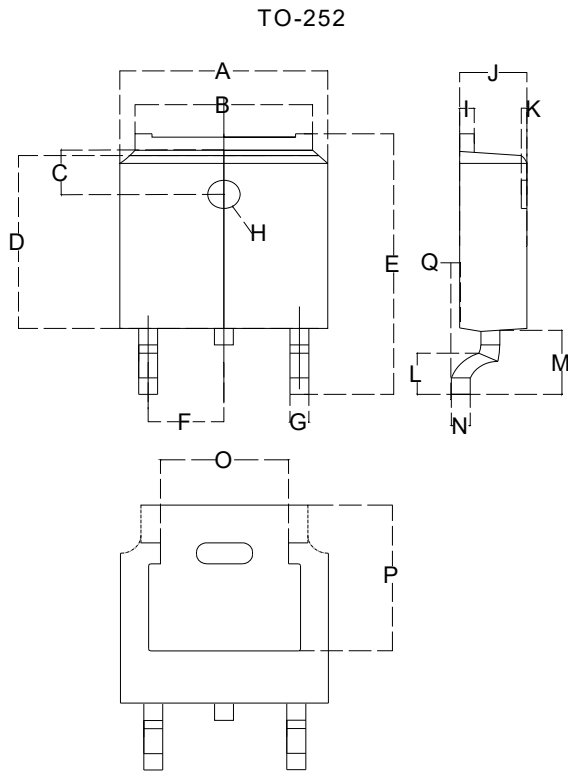

Dimensions in millimeters

TO-252		
Dim	Min	Max
A	6.500	6.700
B	5.100	5.460
C	1.400	1.800
D	6.000	6.200
E	10.000	10.400
F	2.166	2.366
G	0.660	0.860
H	Φ1.050	Φ1.350
I	0.460	0.580
J	2.200	2.400
K	0	0.300
L	0.890	2.290
M	2.730	3.080
N	0.430	0.580
O	4.20	4.95
P	5.15	5.45
Q	0	0.2

## ■ Suggested Pad Layout

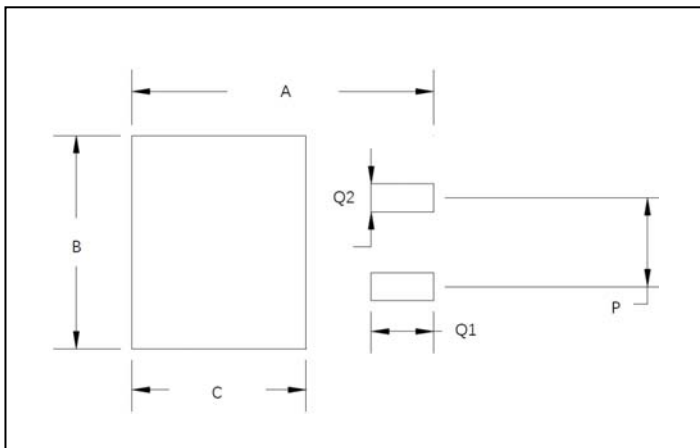

Dim	Millimeters
A	11.4
B	6.74
C	6.23
P	4.56
Q1	2.28
Q2	1.52



## Disclaimer

The information presented in this document is for reference only. Yangzhou Yangjie Electronic Technology Co., Ltd. reserves the right to make changes without notice for the specification of the products displayed herein to improve reliability, function or design or otherwise.

The product listed herein is designed to be used with automotive electronics, are not designed for use in medical, life-saving, lifesustaining, or military, Yangjie or anyone on its behalf, assumes no responsibility or liability for any damages resulting from such improper use of sale.

This publication supersedes & replaces all information previously supplied. For additional information, please visit our website <http://www.21yangjie.com>, or consult your nearest Yangjie's sales office for further assistance.