

Dual Switching Diode

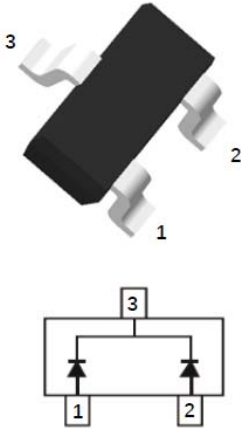

Features

- Moisture sensitivity level 1
- Reverse voltage: 85V
- Average forward current: 150mA

Application

- High frequency rectifier
- Signal switching

Mechanical data

- **Package:** SOT-523
- **Terminals:** Tin plated leads, solderable per J-STD-002 and JESD22-B102

■ Maximum Ratings ($T_a=25^\circ\text{C}$ Unless otherwise specified)

Parameter	Symbol	Unit	Value
Device marking code			JE
Repetitive peak reverse voltage	V_{RRM}	V	85
Forward current, per leg	I_F	mA	150
Non-repetitive surge peak forward current @ t=8.3ms half-sine wave	I_{FSM}	A	1
Non-repetitive surge peak forward current @ t=1ms square wave			1.5
Power dissipation	P_D	mW	150
Junction temperature	T_J	$^\circ\text{C}$	-55 to +150
Storage temperature	T_{STG}	$^\circ\text{C}$	-55 to +150



BAV99T

RoHS
COMPLIANT

■ Electrical Characteristics (T_a=25°C Unless otherwise specified)

Parameter	Symbol	Unit	Conditions	Min	Typ	Max
Reverse voltage	V _R	V	I _R =1uA	85		
Forward voltage	V _{F1}	V	I _F =1mA			0.715
	V _{F2}	V	I _F =10mA			0.855
	V _{F3}	V	I _F =50mA			1.0
	V _{F4}	V	I _F =150mA			1.25
Reverse leakage current	I _{R1}	uA	V _R =25V			0.03
	I _{R2}	uA	V _R =75V			2
Junction capacitance	C _j	pF	V _R =0V, f=1.0MHz			1.5
Reverse recovery time	T _{rr}	ns	I _F =I _R =10mA, I _{rr} =0.1*I _R , R _L =100Ω			4

■ Thermal Characteristics

Parameter	Symbol	Unit	Value
Thermal resistance, junction-to-ambient	R _{θJ-A} ⁽¹⁾	°C/W	833
Thermal resistance, junction-to-case	R _{θJ-C} ⁽¹⁾	°C/W	666

Note:

(1) Thermal resistance from junction to ambient and from junction to case mounted on P.C.B. with 25.4mm*25.4mm copper pad areas



■ Characteristics

Fig 1: P_D - T_a Curve

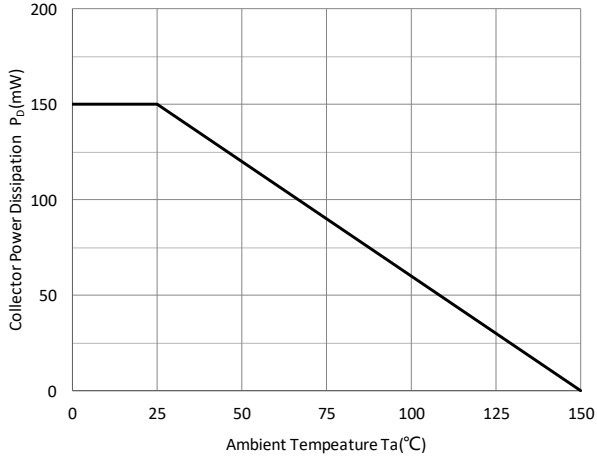

Fig 2: Capacitance Capability

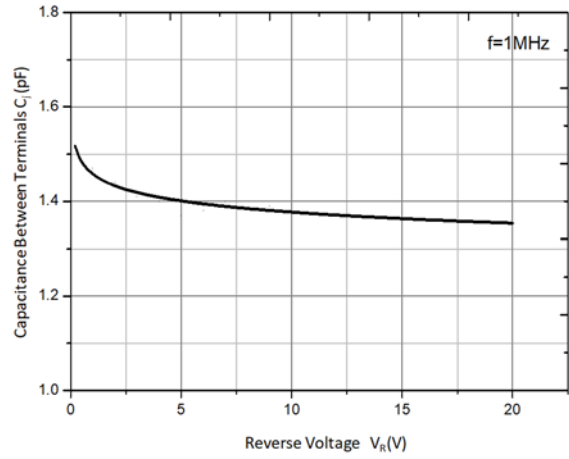

Fig 3: Typical Forward Characteristics

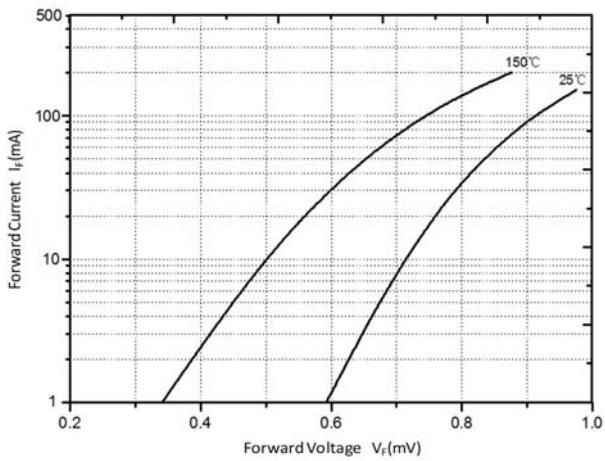
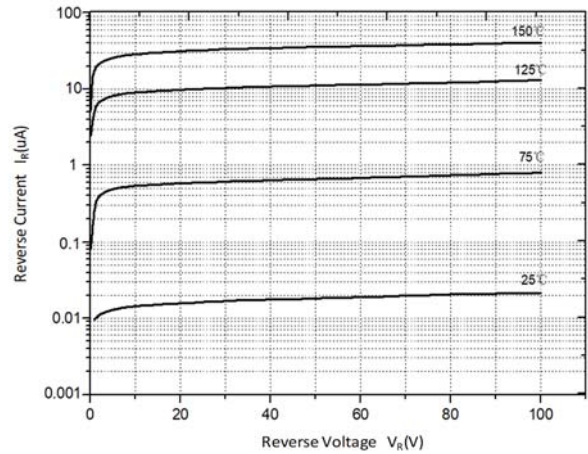

Fig 4: Typical Reverse Characteristics





BAV99T

RoHS
COMPLIANT

■ Ordering Information

Preferred P/N	Packing code	Unit weight(g)	Minimum package(pcs)	Inner Box quantity(pcs)	Outer carton quantity(pcs)	Delivery mode
BAV99T	F2	Approximate 0.0027	3000	30000	120000	7" reel

■ Outline Dimensions

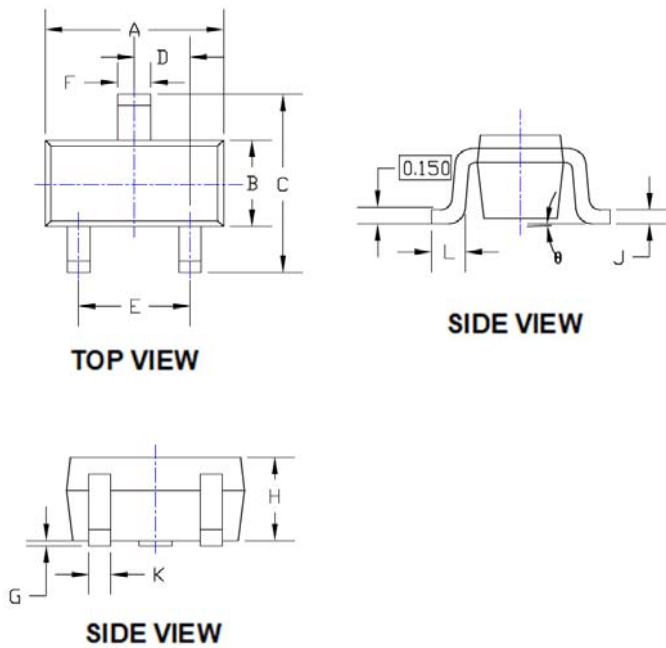

SYMBOL	DIMENSIONS			
	INCHES		Millimeter	
	MIN.	MAX.	MIN.	MAX.
A	0.059	0.067	1.500	1.700
B	0.030	0.033	0.750	0.850
C	0.057	0.069	1.450	1.750
D	0.020TYP		0.500TYP	
E	0.035	0.043	0.900	1.100
F	0.010	0.018	0.250	0.450
G	0.000	0.004	0.000	0.100
H	0.024	0.031	0.600	0.800
J	0.004	0.008	0.100	0.200
K	0.006	0.014	0.150	0.350
L	0.010	0.018	0.260	0.460
θ	0°	8°	0°	8°

■ Suggested Pad Layout

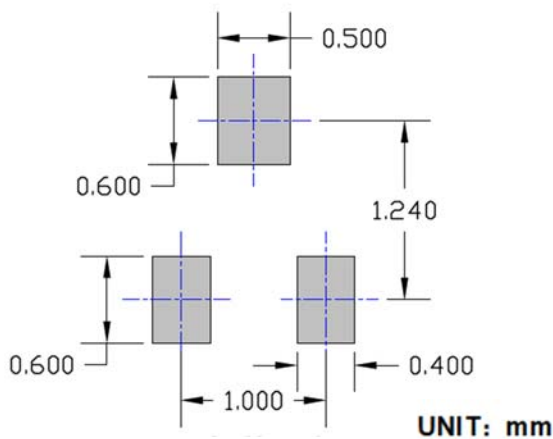



Disclaimer

The information presented in this document is for reference only. Yangzhou Yangjie Electronic Technology Co., Ltd. reserves the right to make changes without notice for the specification of the products displayed herein to improve reliability, function, or design or otherwise.

The product listed herein is designed to be used with ordinary electronic equipment or devices, and not designed to be used with equipment or devices which require high level of reliability and the malfunction of which would directly endanger human life (such as medical instruments, transportation equipment, aerospace machinery, nuclear-reactor controllers, fuel controllers and other safety devices), Yangjie or anyone on its behalf, assumes no responsibility or liability for any damages resulting from such improper use of sale.

This publication supersedes & replaces all information previously supplied. For additional information, please visit our website [http:// www.21yangjie.com](http://www.21yangjie.com) , or consult your nearest Yangjie's sales office for further assistance.