

## PNP General Purpose Amplifier

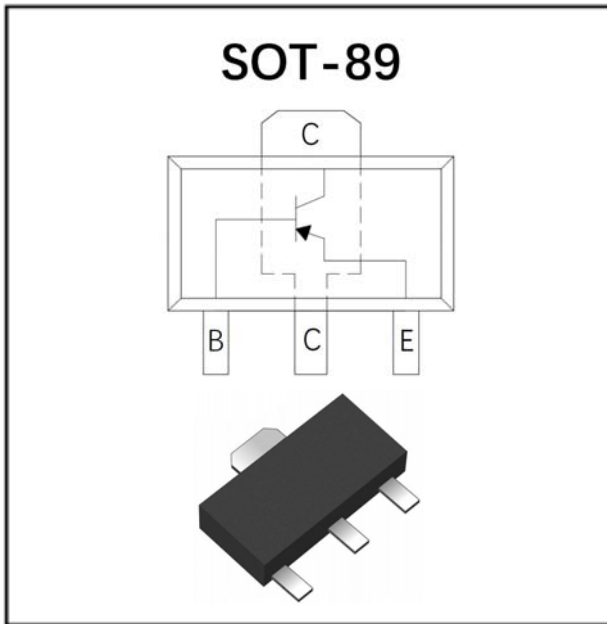

### Features

- Epoxy meets UL-94 V-0 flammability rating
- Halogen free available upon request by adding suffix "HF"
- Moisture sensitivity level 1
- Low collector-emitter saturation voltage

### Mechanical Data

- **Package:** SOT-89
- Molding compound meets UL 94 V-0 flammability rating, RoHS-compliant, halogen-free
- **Terminals:** Tin plated leads, solderable per J-STD-002 and JESD22-B102
- **Marking:**A1013

### ■ Maximum Ratings (Ta=25°C unless otherwise noted)

Item	Symbol	Unit	Conditions	Value
Minimum Collector-Emitter Voltage	$V_{CEO}$	V	$I_C = -10\text{mA}$ , $I_B = 0$	-160
Minimum Collector-Base Voltage	$V_{CBO}$	V	$I_C = -100\mu\text{A}$ , $I_E = 0$	-160
Minimum Emitter-Base Voltage	$V_{EBO}$	V	$I_E = -100\mu\text{A}$ , $I_C = 0$	-6
Collector Current	$I_C$	A		-1
Collector Power Dissipation	$P_C$	mW		500
Thermal Resistance From Junction To Ambient	$R_{\theta JA}$	°C/W		250
Operation Junction Temperature	$T_j$	°C		-55 to +150
Storage Temperature	$T_{stg}$	°C		-55 to +150



# 2SA1013

## ■Electrical Characteristics (Ta=25°C unless otherwise noted)

Item	Symbol	Unit	Conditions	Min	Max
Collector-Emitter Voltage	$V_{CE0}$	V	$I_C=-10mA, I_B=0$	-160	
Collector-Base Voltage	$V_{CBO}$	V	$I_C=-100\mu A, I_E=0$	-160	
Emitter-Base Voltage	$V_{EBO}$	V	$I_E=-100\mu A, I_C=0$	-6	
Collector-base Cut-off Current	$I_{CBO}$	$\mu A$	$V_{CB}=-150V$		-1
Base-emitter Cut-off Current	$I_{EBO}$	$\mu A$	$V_{EB}=-6V$		-1
DC Current Gain	$h_{FE}$		$I_C=-200mA, V_{CE}=-5V$	60	320
Collector-Emitter Saturation Voltage	$V_{CE(sat)}$	V	$I_C=-500mA, I_B=-50mA$		-1.5
Base-Emitter Turn-On Voltage	$V_{BE(on)}$	V	$I_C=-0.5mA, V_{CE}=-5V$	-0.45	-0.75
Transition frequency	$f_T$	MHz	$I_C=-200mA, V_{CE}=-5V$	15	
Collector Capacitance	$C_{ob}$	pF	$V_{CB}=-10V, I_E=0, f=1MHz$		35

## ■Ordering Information (Example)

PREFERRED P/N	PACKING CODE	UNIT WEIGHT(g)	MINIMUM PACKAGE(pcs)	INNER BOX QUANTITY(pcs)	OUTER CARTON QUANTITY(pcs)	DELIVERY MODE
2SA1013	F2	Approximate 0.055	1000	8000	32000	7" reel

## ■CLASSIFICATION OF HFE

Rank	O	P
Range	100-200	160-320

## ■Characteristics (Typical)

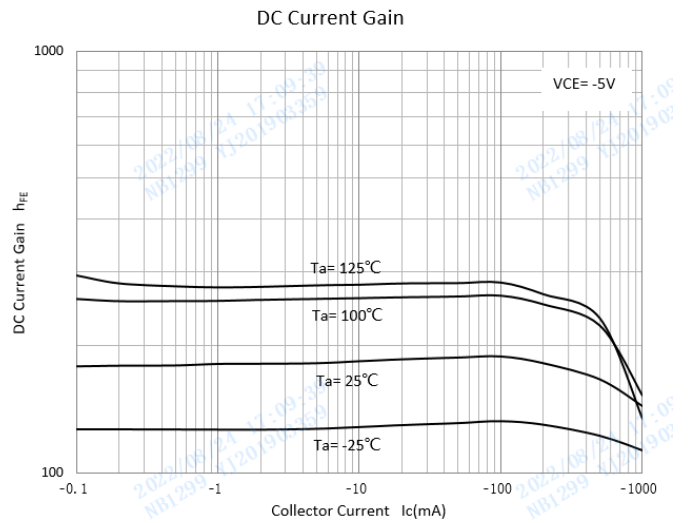
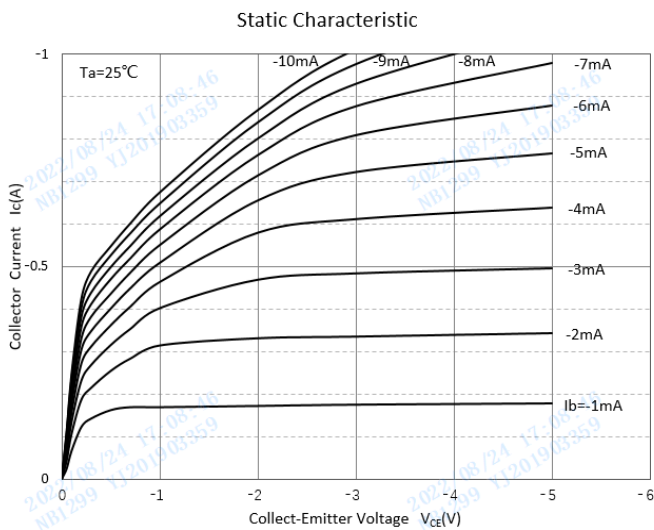

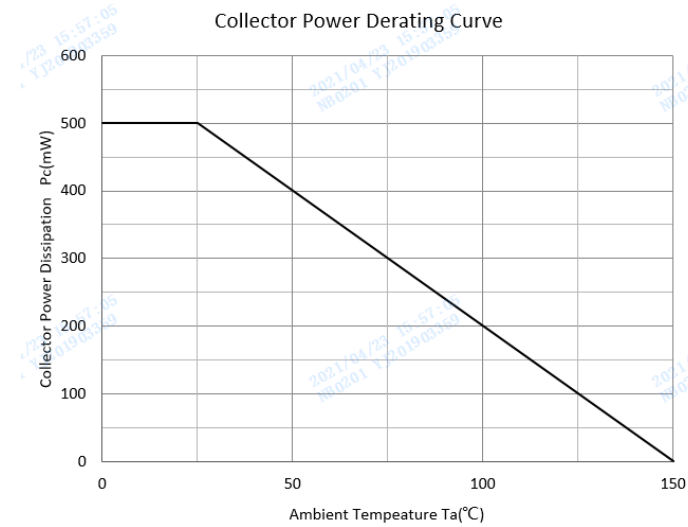
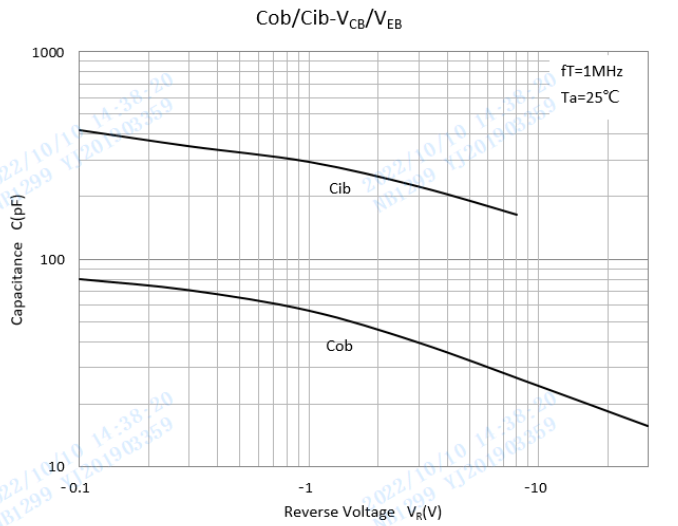
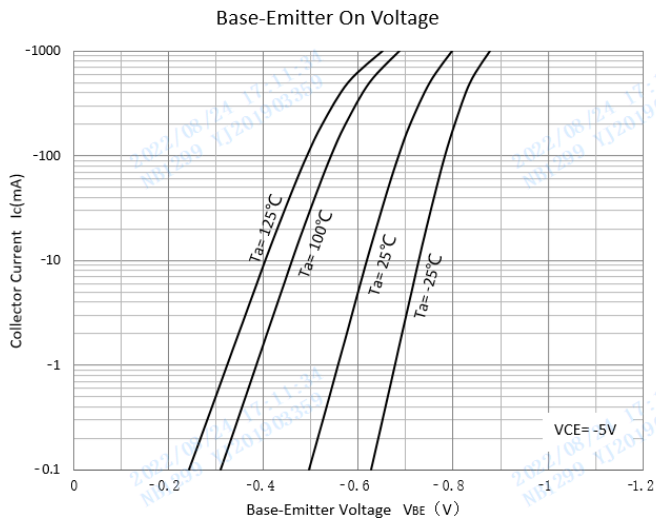
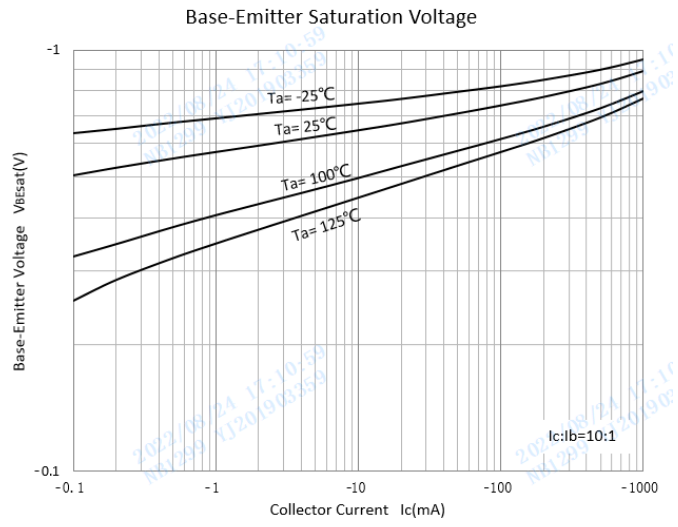
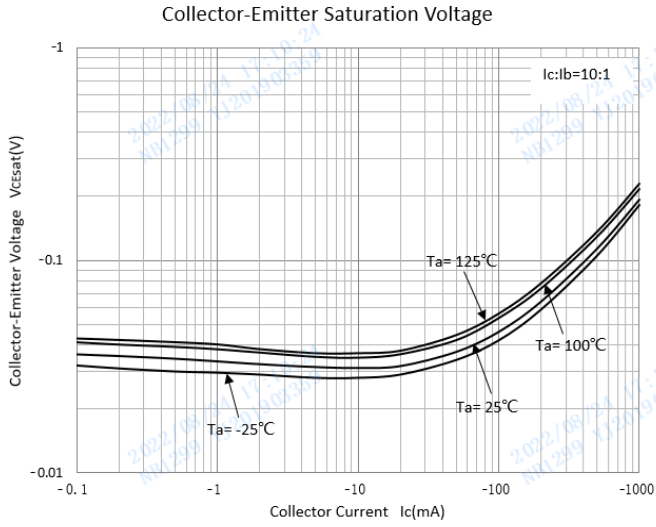



# 2SA1013

## ■SOT-89 Package Outline Dimensions

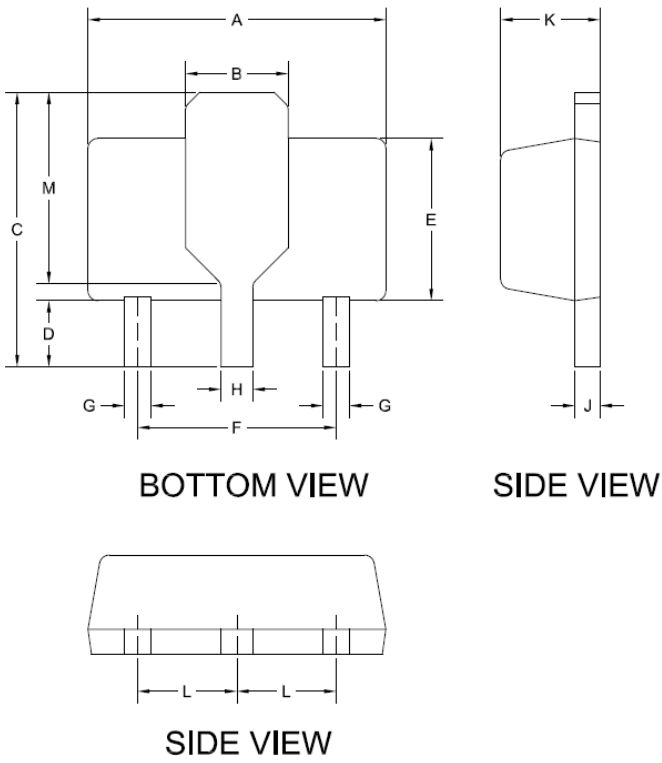

DIM	DIMENSIONS			
	INCHES		MM	
	MIN.	MAX.	MIN.	MAX.
A	0.173	0.181	4.400	4.600
B	0.061 TYP.		1.550 TYP.	
C	0.155	0.167	3.940	4.250
D	0.031	0.047	0.800	1.200
E	0.094	0.102	2.400	2.600
F	0.118 TYP.		3.00 TYP.	
G	0.014	0.019	0.360	0.480
H	0.017	0.022	0.440	0.560
J	0.014	0.017	0.350	0.440
K	0.055	0.063	1.400	1.600
L	0.059 TYP.		1.500 TYP.	
M	0.108 TYP.		2.750 TYP.	

## ■SOT-89 Suggested Pad Layout

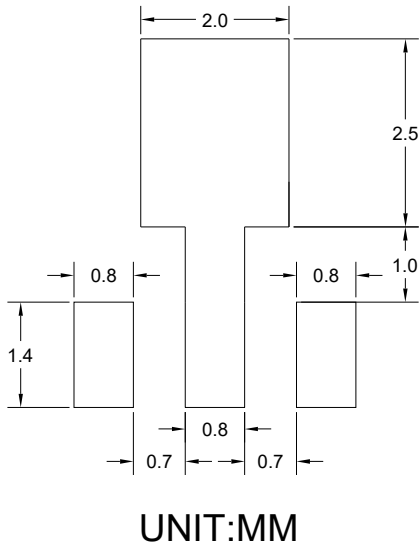



### Disclaimer

The information presented in this document is for reference only. Yangzhou Yangjie Electronic Technology Co., Ltd. reserves the right to make changes without notice for the specification of the products displayed herein to improve reliability, function or design or otherwise.

The product listed herein is designed to be used with ordinary electronic equipment or devices, and not designed to be used with equipment or devices which require high level of reliability and the malfunction of which would directly endanger human life (such as medical instruments, transportation equipment, aerospace machinery, nuclear-reactor controllers, fuel controllers and other safety devices), Yangjie or anyone on its behalf, assumes no responsibility or liability for any damages resulting from such improper use of sale.

This publication supersedes & replaces all information previously supplied. For additional information, please visit our website [http:// www.21yangjie.com](http://www.21yangjie.com) , or consult your nearest Yangjie's sales office for further assistance.